

Article number: 2092765911A
Description: E+G Screws with ball
GN 606-M10-25-BN

Measures

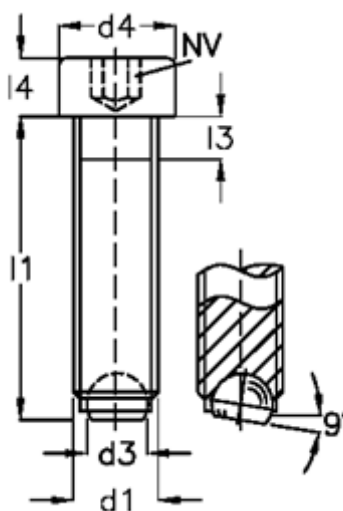

d1	= M10
d2	= 7.0
d3	= 6.0
d4	= 16
Internal hexagon	= 8.0
l1	= 25
l3	= 4.5
l4	= 10